

GLASS-LINED INSTRUMENTATION

FOR HIGHEST
STANDARDS

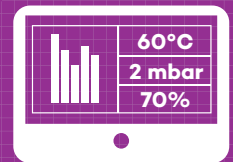

PLC
CONTROLS

ION SENSITIVE

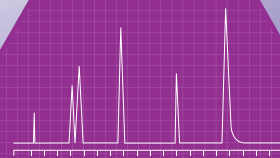

ANALYTICAL
DATA

MIN

Worldwide Presence

One single source responsibility with access to all Pfaudler Technologies, Systems, Services worldwide

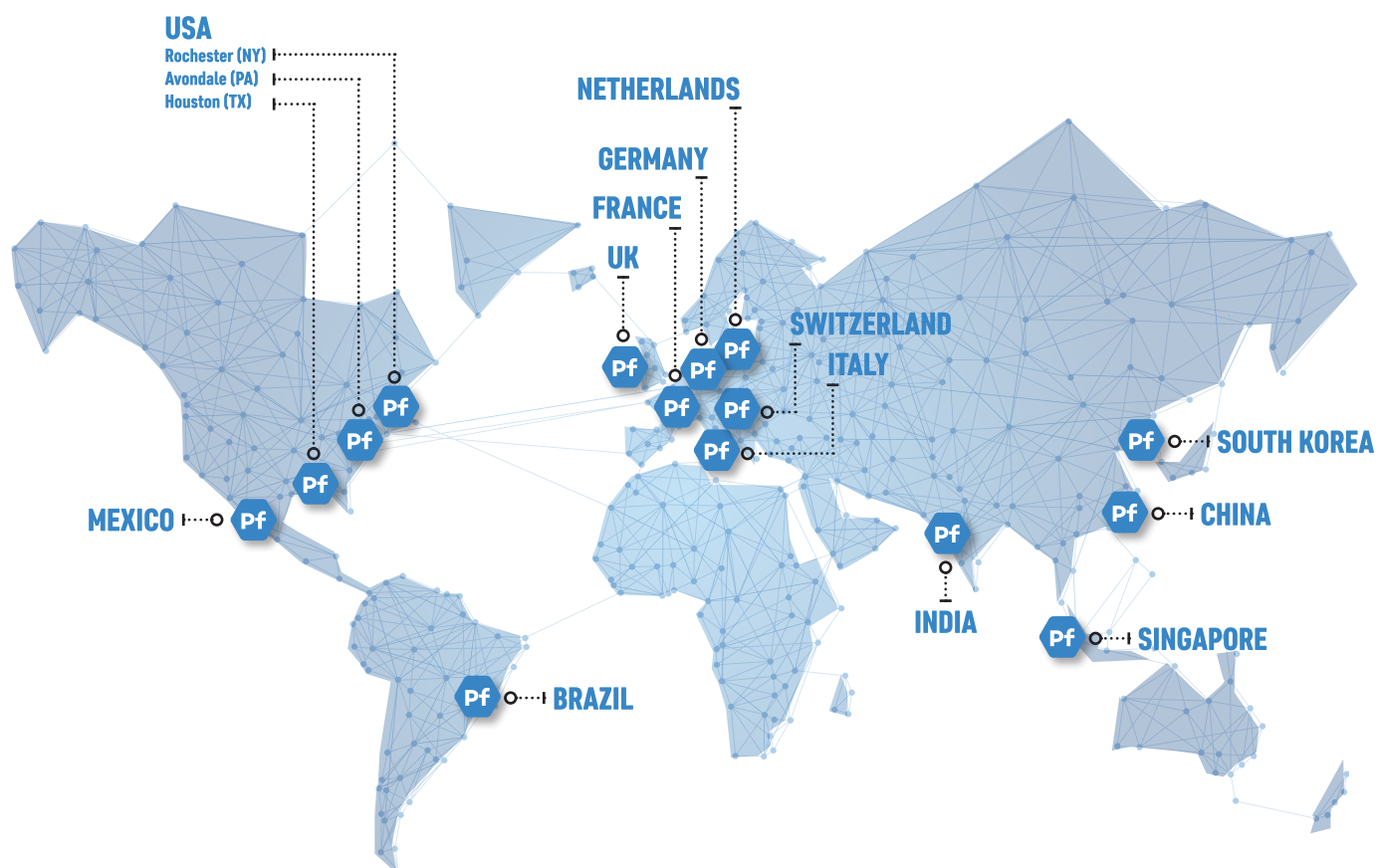

Pfaudler is a global Group offering a wide range of **corrosion-resistant technologies, systems** and **related services** for the **chemical, pharmaceutical and food industries**.

Edlon, Interseal, Mavag, Normag and Pfaudler are our Branded Product Lines. These product lines are specialized and perfectly integrated to **meet the most complex Client needs**. We are in the position to offer a **complete turn-key package** for each of the critical aspects of chemical and pharmaceutical processing.

Technologies and process systems of our Group are installed in more than 100 countries and across six continents.

Unique expertise and skills, **manufacturing capability**, targeted investments in strategic markets, innovation and competitiveness allow the Pfaudler group to be a landmark in the industry.

Around the world our Customers rely on the quality and performance of our supply to obtain efficient, reliable, profitable and safe chemical process systems.

Our network organization is designed to:

- strengthen our local presence alongside Customers and markets;
- accelerate decision-making processes through a less-centralized management;
- improve Pfaudler's ability to attract new talent at the local level.



Pf

Pfaudler Technologies

We help make the world around us. Much of what you see, taste and touch in the world was created or improved using Pfaudler Technologies

Pfaudler Services

We provide 24/7 support for your entire plant

Pfaudler Systems

We design and build turn-key process

Pfaudler Innovation

Our innovative spirit continuously drives us to develop the next great technology

Sectors and Applications

Advantages of the glass-lined measurement technology

Sectors

In the **chemical and pharmaceutical industries**, Pfaudler has been synonymous with glass-lined vessels and components for decades. But glass-lined measurement technology offers **decisive benefits in other sectors** as well.

Applications

Did you know that many **daily consumer products** are made using Pfaudler technology? Here are just a few examples.

Beer · Yoghurt · Cheese · Rice · Sugar · Mayonnaise · Cheese spread · Herb butter · Ketchup · Mustard · Crème fraîche · Jam · Syrup · Paper · Glue · Cream · Shampoo / shower gel · Hair perming products · Plant protection products

Sectors	
Chemicals	Beverages
Petrochemicals	Water / wastewater
Pharma	Paper
Energy	Cosmetics
Food	Metal industry





Technology and Benefits

Advantages of the glass-lined measurement technology

Technology

Glass lining is a unique composite material that optimally combines the advantages of steel and glass. As a result, it not only offers outstanding protection against many aggressive media, but it is also abrasion-, pressure- and temperature-resistant. **This makes glass lining the perfect material for protecting measurement technology in demanding applications.**

But glass lining can do even more. Specially developed formulations react to H⁺ ions in liquid media, which makes them suitable for **pH measurement**.

Embedding sensors in the glass lining not only delivers **redox potential** and **conductivity measurements** but also ultra-fast reacting **temperature measurements** and **corrosion monitoring**.

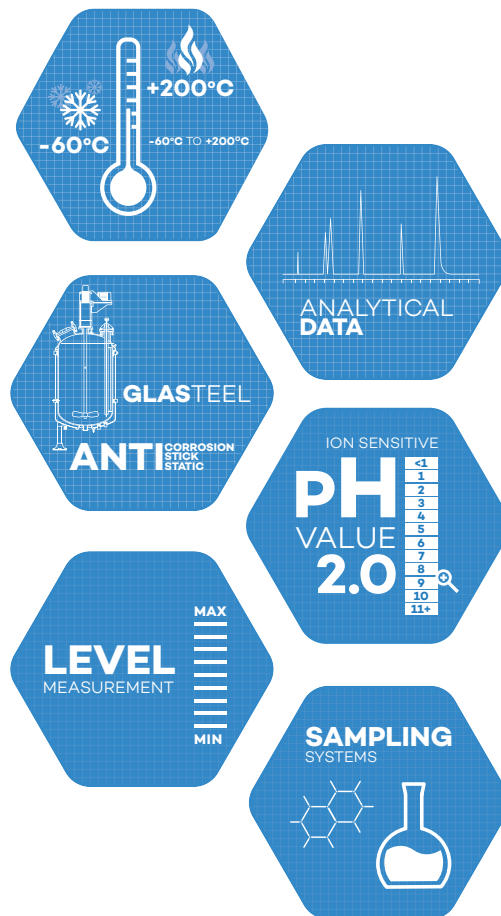

Benefits

Highly resistant glass layer

- Resistant to aggressive acids, organic solvents and proteins
- Resistant to Cleaning In Place (CIP) and Sterilisation In Place (SIP) processes
- Resistant to abrasion
- Resistant to high temperatures
- Resistant to thermal shocks
- No catalytic or biological effects

Self-cleaning

- Prevents deposit formation with adequate flow velocity
- Suitable for adhesive products

Durable

- Service life limited only by glass corrosion or abrasion

Robust steel body

- Withstands turbulences, shear forces and high process pressures
- Allows continuous inline monitoring
- No need for bypass lines, pumps, shutoff devices or retractable holders

Low maintenance

- No change in the pH characteristic curve over the entire service life
- Lower costs for recalibrations and cleaning processes
- Positive pressure effectively prevents diaphragm and electrolyte section contamination
- Maintenance intervals of up to one year
- Can be stored dry

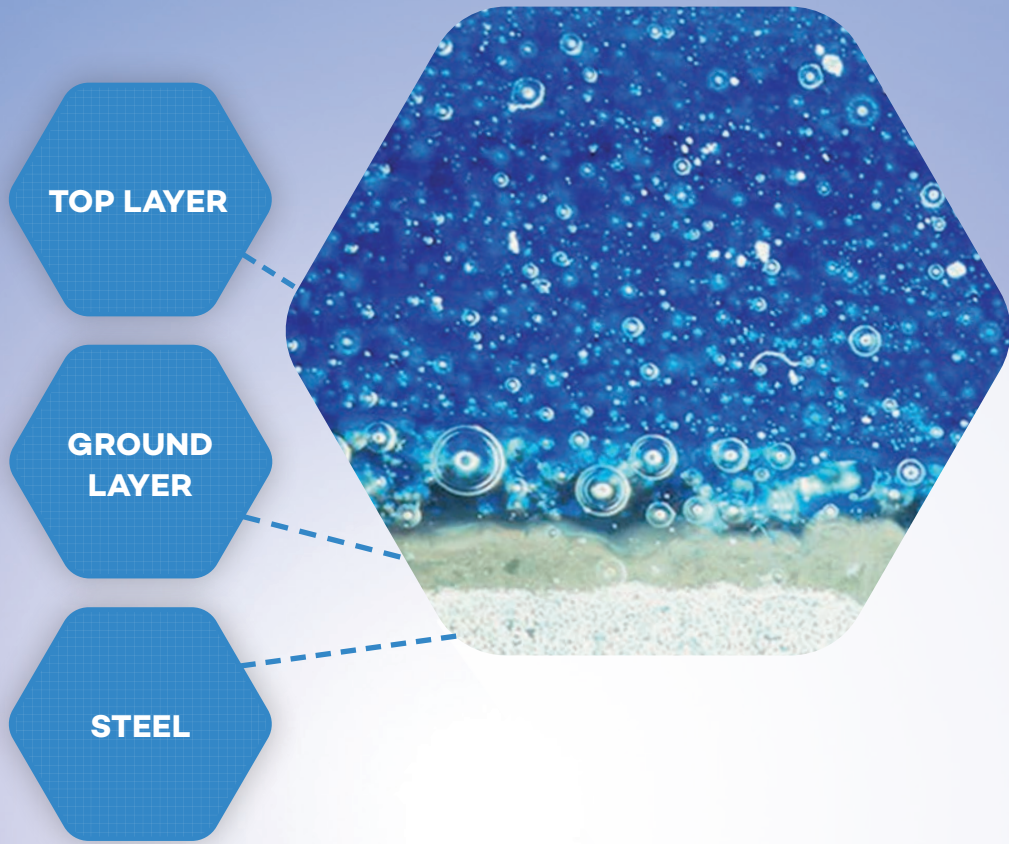

TOP LAYER

GROUND LAYER

STEEL

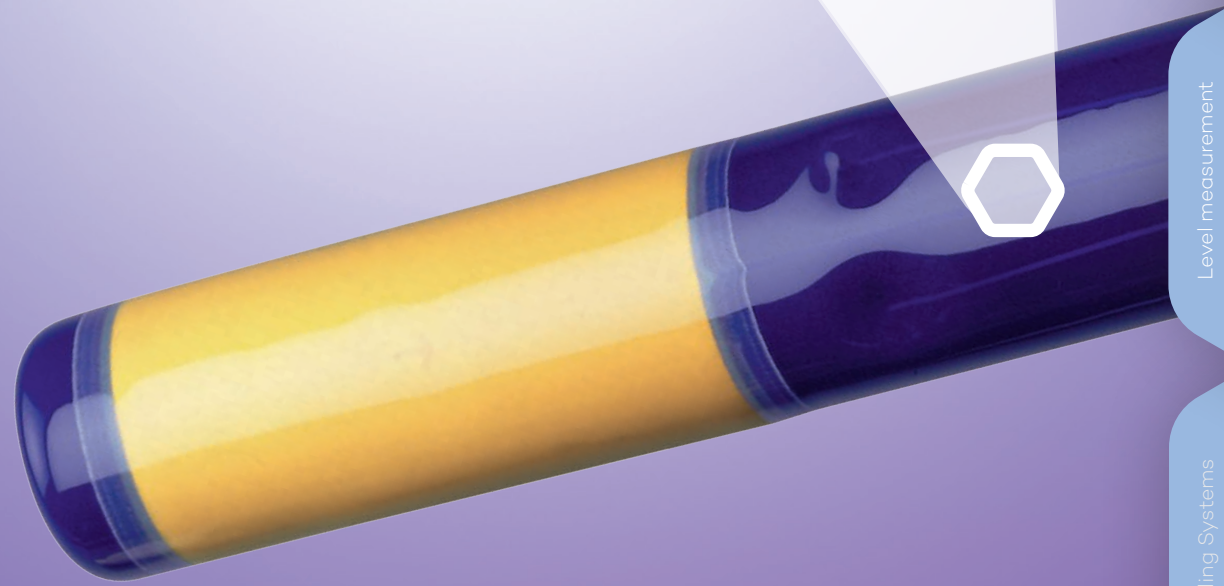

Liquid Analysis

Because glass has its limits

Online liquid analysis permits automated monitoring and regulation of industrial processes in many sectors. In addition to pH, other important process control parameters include redox potential and conductivity. Pfaudler offers **solutions for challenging applications** in this field – because anyone can do the easy ones!

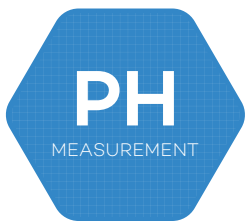

pH measurement

Whenever robustness and chemical resistance are key, Pfaudler's **low-maintenance and durable pH measurement systems** are your first choice. We supply probes in various designs for virtually all process engineering applications. For hygienic processes, we offer specially developed probes with EHEDG certification.

- High mechanical strength and suitable for use in high temperatures
- Proof against glass breakage
- Can be used without a retractable system or bypass installation
- CIP and SIP compliant
- Self-cleaning and low-maintenance

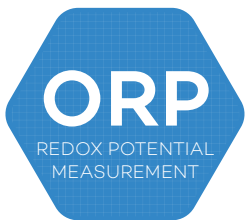

Redox potential measurement

The redox potential generated in oxidation and reduction processes can be determined by means of **robust glass-lined probes**. For this purpose, a rhodium electrode is embedded in the glass lining. By combining two measurement systems on one probe you can measure the pH and the redox potential concurrently.

- High mechanical strength and chemical resistance through the use of glassed steel and fused-in rhodium electrodes
- Suitable for high temperatures
- Dirt-resistant
- Combination with pH measurement possible



Conductivity measurement

The conductivity of a medium can be determined with a **durable glass-lined probe** in a 4-conductor circuit. To achieve this, four rhodium electrodes are arranged behind each other on a measuring probe and fused into the probe carrier's glass lining.

- Wide measurement range 0.01 mS to 2000 mS
- Suitable for high temperatures
- Standard use at up to 40 bar positive pressure
- Dirt-resistant
- Suitable as ring probe for phase separation and 'empty' signal



PH
MEASUREMENT

ORP
REDOX POTENTIAL
MEASUREMENT

LF
CONDUCTIVITY
MEASUREMENT

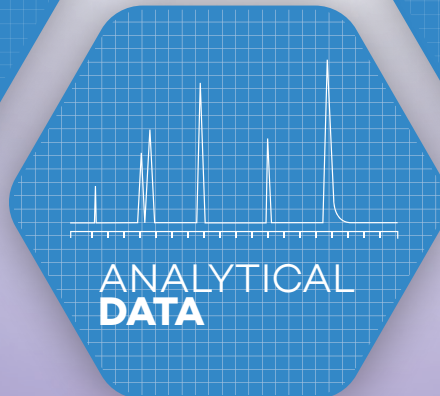

Glass-lined pH Probes

Long-lasting and low-maintenance

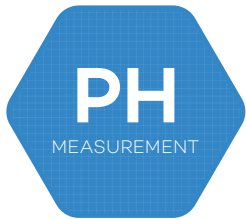

The pH value is one of the most important and commonly measured values in many fields of process engineering. The stability of the entire production process can be increased by regulating the pH value in a targeted way. Thanks to their maintenance-free operation and long service lives, robust glass lined pH probes are a cost-effective option for constant use.

Steel probe body

The glass lined pH probe comprises a steel probe body with a highly-resistant, anti-adhesive technical glass lining to protect the surface in contact with the product. This makes the probe resistant to mechanical strain by flows, pressure, abrasion and vibrations. Probes can therefore be installed in piping and vessels where they are directly exposed to the flow, enabling direct continuous online measurement in the main product stream.

Moreover, the smooth surface the glass

lining gives the probe protects it against corrosion and product build-up. Combined with a pressurised electrolyte system, these properties allow the probe to be installed in any position and direction, so the pH sensor can be installed directly at the point of use.

No aging

Unlike in glass electrodes, there is no internal buffer (discharge electrode). In contrast to conventional glass electrodes, the ion-sensitive glass area is only in contact with the process medium on one side. This prevents ageing and drift of the pH sensor.

- The operating life of a Pfaudler pH probe is depending of chemical corrosion and abrasion (diagram corrosion resistance).

Corrosion resistance of the Pfaudler pH-Glass

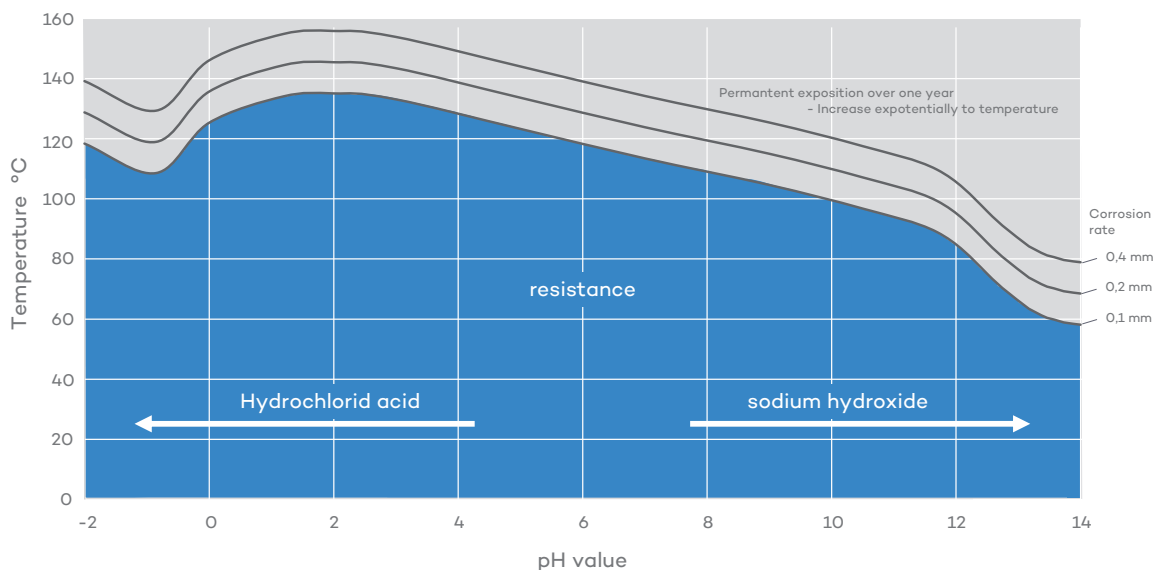

Structure of pH-Glass-lining

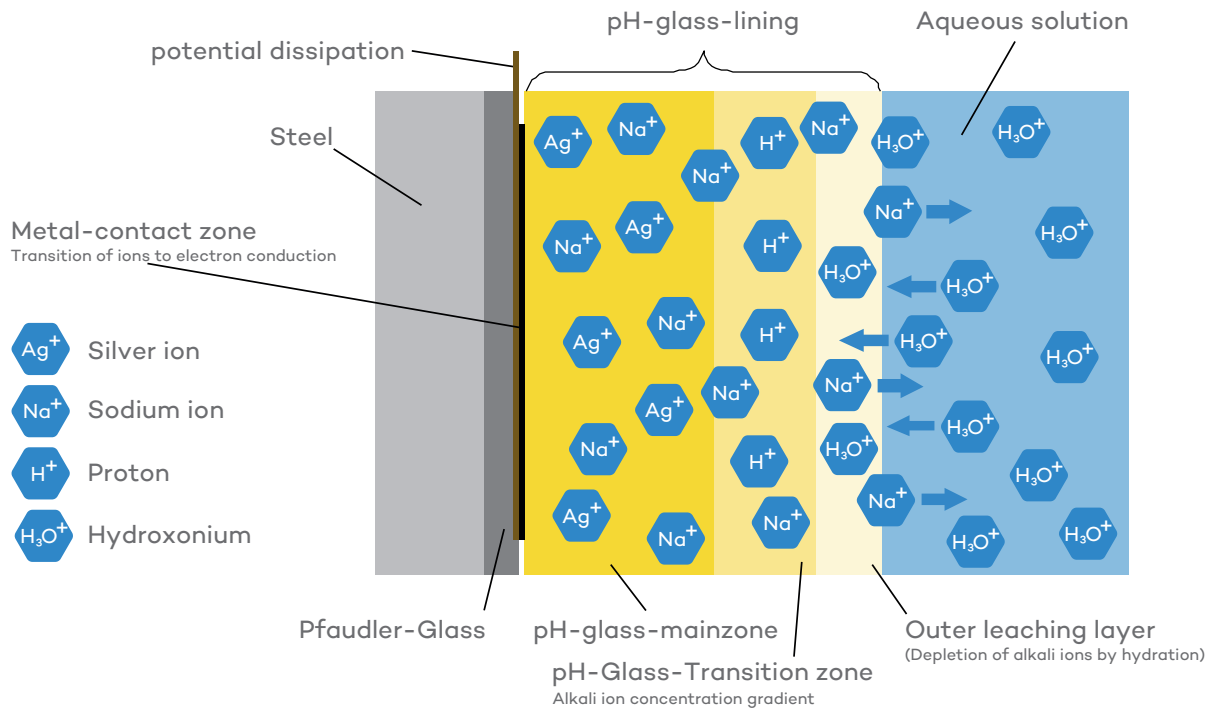

Characteristic curve of pH measurement

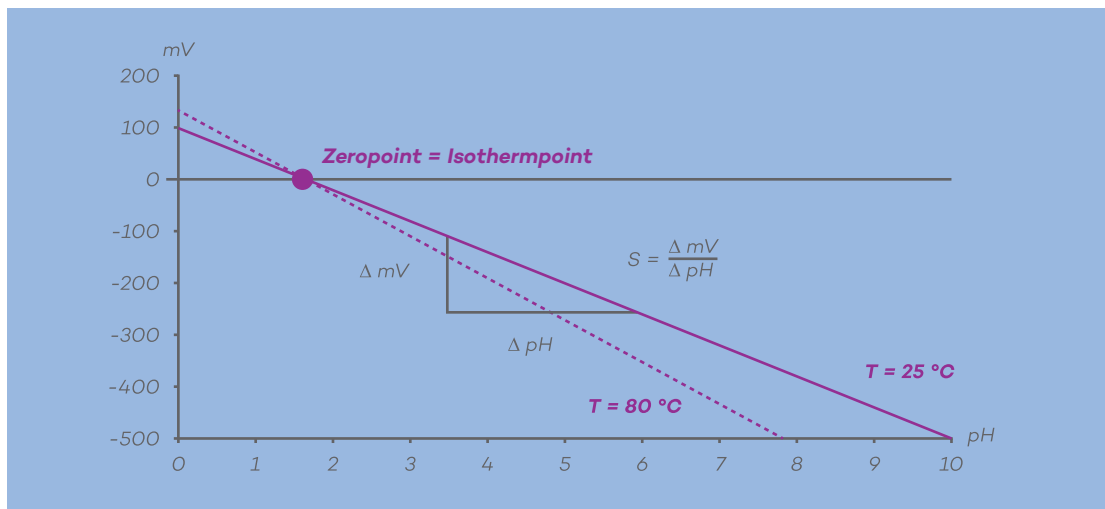

Glass-lined pH Probes

For highest heavy-duty process standards

HEAVY
DUTY
DESIGN

PH
MEASUREMENT

Absolute pH-measurement principal

pH determination is a potentiometric (electrochemical) analysis method. A typical measuring setup with **absolute pH probes** comprises two electrodes – a measuring electrode immersed in a process medium and a reference electrode immersed in an electrolyte liquid. The measuring electrode generates a potential that clearly identifies the chemical condition (hydrogen ion concentration) of the medium to be measured. The reference electrode provides a constant

known potential that is independent of the composition of the process medium. A transmitter connected to the pH measuring probe calculates the medium's pH value from the difference in potential between the two electrodes, depending on the measured temperature –

The pH value is now an absolute pH value.



pH-probe type 03N

- rod
- external electrolyte vessel

pH-probe type 03N

- ring
- external electrolyte vessel

pH-probe type 03K

- rod
- integrated electrolyte vessel

Relative pH-measurement principal

Differential pH probes provide values measured against a product-dependent reference parameter. The measured value is therefore a product-specific value (**relative pH measurement**) that allows a statement as to whether a process is performed according to defined specifications. This measured value is therefore ideal for controlling and monitoring recurring batch processes (e. g. formulations without changes) or continuous measurement. **Differential pH probes** are simple in structure: two ion-sensitive enamels are fused onto a steel probe carrier and form the measuring part of the sensor. One sensor surface responds to H⁺ ions and provides a potential that depends only on the pH value; this is called the pH glass.

The other sensor surface – the reference glass or reference electrode– responds to the salts dissolved in the liquid, especially the Na⁺ ions present, and thus provides a product-specific reference potential. Once the transmitter has been configured with data from the measurement and test report provided, the **pH differential probe** is calibrated in its installed position using a product sample. The probe then works like a “normal absolute” pH measurement device in the specified range. The special relative measurement principle means that the probe functions without an electrolytic liquid. This eliminates the risk of the product being contaminated by the electrolyte and ensures practically maintenance-free operation.



pH-probe type 18

- rod
- no electrolyte vessel necessary



pH-probe type 40

- rod
- no electrolyte vessel necessary



pH-probe type 40

- ring
- no electrolyte vessel necessary

Glass-lined pH Probes

For highest hygienic process standards

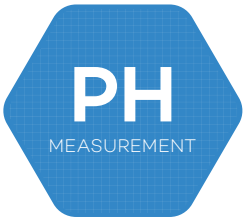

In food production, the pH value is an important indicator of consistent quality, taste and reproducibility in a product, and a significant variable during and after cleaning of the production facilities. The compact probe named pH-Reiner was consistently matched to the needs of the foodstuffs, pharmaceutical and biotech industries.

The measuring electrode with a large surface area consists of pH-sensitive glass that is fused on to the lower end of the glassed probe carrier in an annular shape. The area of the measuring electrode is a multiple of that of glass electrodes. Therefore, precision measurements of the pH value can even be carried out in those media in which measurement ceased to be possible using other methods. In contrast to conventional glass electrodes, the pH glass is in contact with the fluid on one side only. Aging of the probe or measured value drifts are not possible with this probe. The reference electrode necessary for the pH measu-

ring chain is integrated in the probe head. The electrolyte connection between the reference electrode and the product is made using a tube and a shrunk, aseptic ground diaphragm. The electrolyte is contained in a PE bottle that is placed in a stainless steel pressure vessel and the electrolyte bottle can be replaced without affecting sterile conditions. A special, sterile Pfaunder electrolyte is used as a standard. If necessary, infusion solutions such as a sterile saline solution, may also be used as electrolyte. The electrolyte system is pressurized, therefore, the pressure inside the electrolyte system is always higher than the operating pressure inside the reactor or piping. Therefore, no product can enter the probe or contaminate the diaphragm. The pH Reiner probe can be cleaned and sterilized in-line (up to 134 °C) without losing its characteristics.

Easy to clean

Reconditioning the pH Reiner probe after cleaning with alkali

Regeneration time (min) After 30min CIP using 2% NaOH at 85 °C

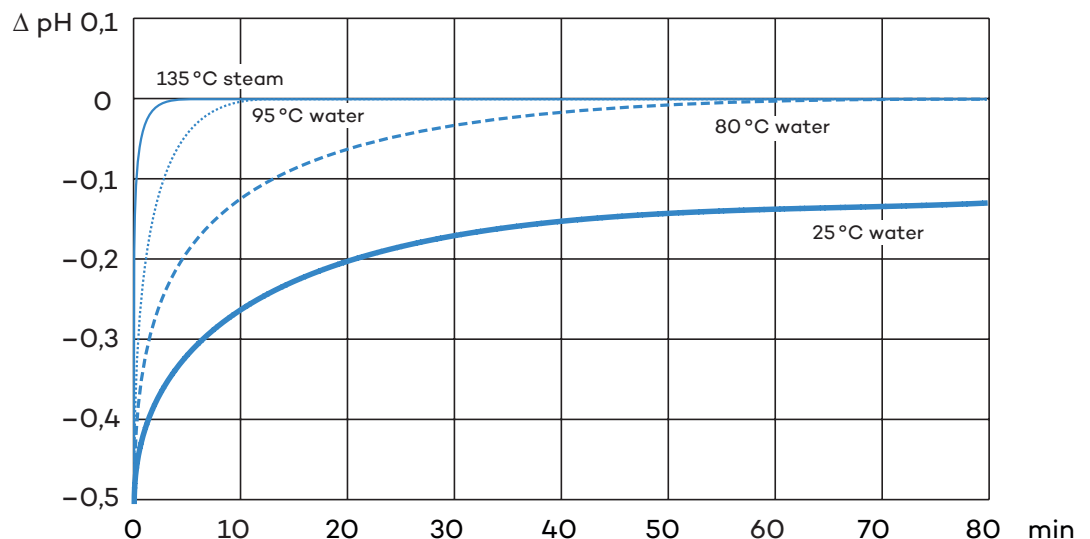

PH-PROBE
TYPE PH-REINER



ELECTROLYTE VESSEL
STAINLESS STEEL



Glass-lined Probes

For highest process standards



Redox potential measurement

Several variants of our probes are designed for measuring redox potential. Like other Pfaudler measuring probes, these are robust and resistant to attack. Their function is to measure the redox potential arising in oxidation or reduction processes. This measurement is carried out with a noble metal electrode against a reference electrode.

The redox potential is measured between a rhodium electrode embedded in the enamel and a pH enamel reference electrode. The magnitude of the potential occurring at the reference electrode depends on the pH value of the product. Thus, a redox voltage is obtained which is not dependent on the pH value. The rH

measuring probe is chemically highly resistant: the measuring electrode is made of rhodium, the reference electrode of pH enamel.

The combined measuring probe pH/rH

The combination of both measuring systems on one carrying tube makes possible the simultaneous measurement of pH value and redox potential.



pH-probe type PH/ORP

- rod
- external electrolyte vessel

pH-probe type PH/ORP

- ring
- external electrolyte vessel

Probe type RH

- rod
- no electrolyte vessel necessary

Conductivity measurement

In the LF measuring probe, four metal (rhodium) electrodes are aligned longitudinally and fused into the enamel coating of the probe carrier. Thermometer tubes, baffles or spacer rings may be used as probe carriers. The cell constant is dependent on the geometry and location of the probe and cannot be predetermined. For this reason, a fourwire circuit is used. A constant alternating current flows across the two outer electrodes and through the product. The resultant voltage drop is sensed by the two inner electrodes and transmitted to a high-impedance measuring transmitter.



Probe type LF
- rod



Probe type LF
- ring

Technical Data

Product overview

Type	pH 03 N/K/Ring	pH 03 N/Dual	pH Reiner
Measured value	Absolute pH	Absolute pH (2x)	Absolute pH
Reference system	Diaphragm + reference electrode	Diaphragm + reference electrode	Ground-joint diaphragm (ceramics), reference electrode AgAgCl
Measuring range	0 to 10 pH	0 to 10 pH	Linear range 0 to +10* pH / application range -2 to +14** pH
Operating temp.	0 to +140 °C	0 to +140 °C	0 to +140 °C
Temperature compensation	Pt 100	Pt 100	Pt 1000
Operating pressure	-1 to +9 bar	-1 to +9 bar	-1 bis +6 bar
Ex. protection	II 1/2 G EEx ia IIB T6 or II 2G EEx ia IIC T6	II 1/2 G EEx ia IIB T6 or II 2G EEx ia IIC T6	–
Dimensions (mm)	L = 300 – 3200 D = 38 – 180 DN = 50 – 200 Ring-probe***: DN 50 / DN 80	L = 300 – 3200 D = 38 – 180 DN = 50 – 200	L = 120 / D = 12.5
Electrical connection	5-pin, Lemo	5-pin, Lemo	6-pin gold-plated, interconnex Variopin
Degree of protection	IP66 to IP68	IP66 to IP68	IP68
Electrolyte	Special Pfaudler KCL solution	Special Pfaudler KCL solution	Special sterile Pfaudler KCL solution

* depends on temperature

** depends on alkali error

*** other dimensions on request

**** higher pressure on request

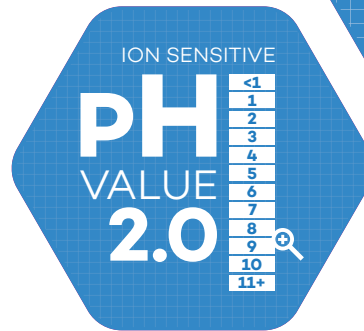

	pH 40/pH 40 Ring	pH 18	pH/ORP	rh	LF/LF Ring
	Relative pH	Relative pH	Absolute pH and Redox potential	Redox potential	Conductivity
	Reference enamel	Reference enamel	Diaphragm + reference electrode	Reference enamel	–
	3 to 12 pH	3 to 12 pH	-1200 to +1500 mV 0 to 10 pH	-1200 to +1500 mV	0.01 to 2000 mS/cm
	0 to +140 °C	0 to +140 °C	0 to +140 °C	0 to +140 °C	-25 to +200 °C
	Pt 100	Pt 100 (optional) Pt 1000	Pt 100	Pt 100 (optional)	Pt 100
	-1 to +40**** bar	-1 to +15 bar	-1 to +9 bar	-1 to +40**** bar	-1 to +40**** bar
	II 1/2 G EEx ia IIB T6 or II 2G EEx ia IIC T6	–	II 1/2 G EEx ia IIB T6 or II 2G EEx ia IIC T6	II 1/2 G EEx ia IIB T6 or II 2G EEx ia IIC T6	II 1/2 G Ex ia IIB T6 or II 2G Ex ia IIC T6
	L = 300 – 3200 D = 38 – 180 DN = 50 – 200 Ring-probe***: DN 50 / DN 80	L = 144 D = 31	L = 300 – 3200 D = 38 – 180 DN = 50 – 200	L = 300 – 3200 D = 38 – 180 DN = 50 – 200	L = 300 – 3200 D = 38 – 180 DN = 50 – 200 Ring-probe***: DN 50 / DN 80
	5-pin, Lemo	5-pin, Lemo	6-pin gold-plated, interconnex Variopin	5-pin, Lemo	5-pin, Lemo
	IP66 to IP68	IP66 to IP68	IP68	IP66 to IP68	IP66 to IP68
	No KCL solution is needed	No KCL solution is needed	Special Pfudler KCL solution	No KCL solution is needed	No KCL solution is needed

Features and Benefits

Product overview

Features

Mechanical robust, abrasion-resistant, chemically resistant

Extremely high pressure ranges possible

Suitable for high temperatures

Self-cleaning

CIP- / SIP-compliant

Slope is maintained throughout service life

Positive pressure effectively prevents diaphragm clogging and contamination

No reference electrode poisoning possible

Glass-lined sodium ion sensitive reference electrode without diaphragm and electrolyte line

Stainless steel pressure vessel

Electrolyte in sterile bottle with septum

EHEDG certification

Certified for explosion zone 0

Benefits

Permanent inline monitoring in applications with high mechanical and chemical stress

No retractable holder / bypass installation required

Low life-cycle costs due to minimal maintenance expense

Service life limited only by glass corrosion and / or abrasion

No electrolyte contamination of the product

No need for consumables

Permanent inline monitoring in hygienic applications

Combined pH / ORP measurement possible

No catalytic or biological effects

Can be stored dry

	pH 03, pH 03 Dual, pH Ring	pH 40, pH 18	pH Reiner	rH, pH /ORP	LF, LF Ring
	✓	✓	✓	✓	✓
		✓		✓	✓
	✓	✓	✓	✓	✓
	✓	✓	✓	✓	✓
	✓	✓	✓	✓	✓
	✓	✓	✓		
	✓		✓	✓	
	✓	No ref. electrode	✓	✓	No ref. electrode
		✓			
			✓		
			✓		
			✓		
	✓	✓		✓	✓

	✓	✓	✓	✓	✓
	✓	✓	✓	✓	✓
	✓	✓	✓	✓	✓
	✓	✓	✓	✓	✓
		✓			✓
		✓			✓
			✓		
			✓	✓	
	✓	✓	✓	✓	✓
	✓	✓	✓	✓	✓

Temperature Measurement

Sometimes speed is key

Early recognition of process temperatures enables you to regulate it precisely and minimise fluctuations. Lower energy input and lower energy losses result in **well-balanced energy management** and therefore **lower costs**. Various technologies are available, depending on the application.

Quick measurement results are essential for optimal temperature control. Pfaudler's fused-in glass lining solutions offer a clear advantage – they are in contact with the medium. Sometimes speed is key!

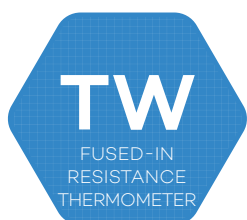

Fused-in resistance thermometer

The functionality of Pfaudler's type TW temperature probe relies on the temperature dependence of the electric resistance of platinum. The platinum measuring unit, a PT 100 resistance thermometer, is fused into the glass lining of baffles or thermometer wells, providing an **optimal heat transfer**. Compared to conventional glass lined temperature measurements the heat transfer coefficient of fused-in sensors is lower, ensuring extremely low half-value times.

- **Fastest** glass-lined temperature probe
- **No sealing** elements
- **Long service life**, excellent long-term stability and maintenance free

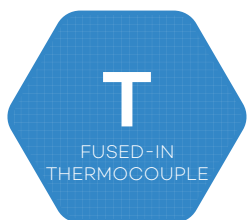

Fused-in thermocouple

In the Pfaudler type T temperature probe, the temperature is measured exactly where it is needed. A Pallaplat thermocouple is fused into the glass lining of C-baffles or valve cones, providing an **optimal heat transfer**.

- Up to **six measurement points**
- **No sealing** elements
- **Long service life**, excellent long-term stability and maintenance free

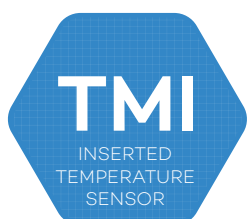

Inserted temperature sensor

Pfaudler's type TMI temperature probe is a **robust, simple and cost-effective solution** for measuring temperature. The measuring insert – a resistance thermometer – is pressed by spring action to the bottom of the baffle or valve cone.

- **Reduced wall thickness** and coated contact point for improved heat transfer
- Measuring insert is **easy to replace** and recalibrate

Time response

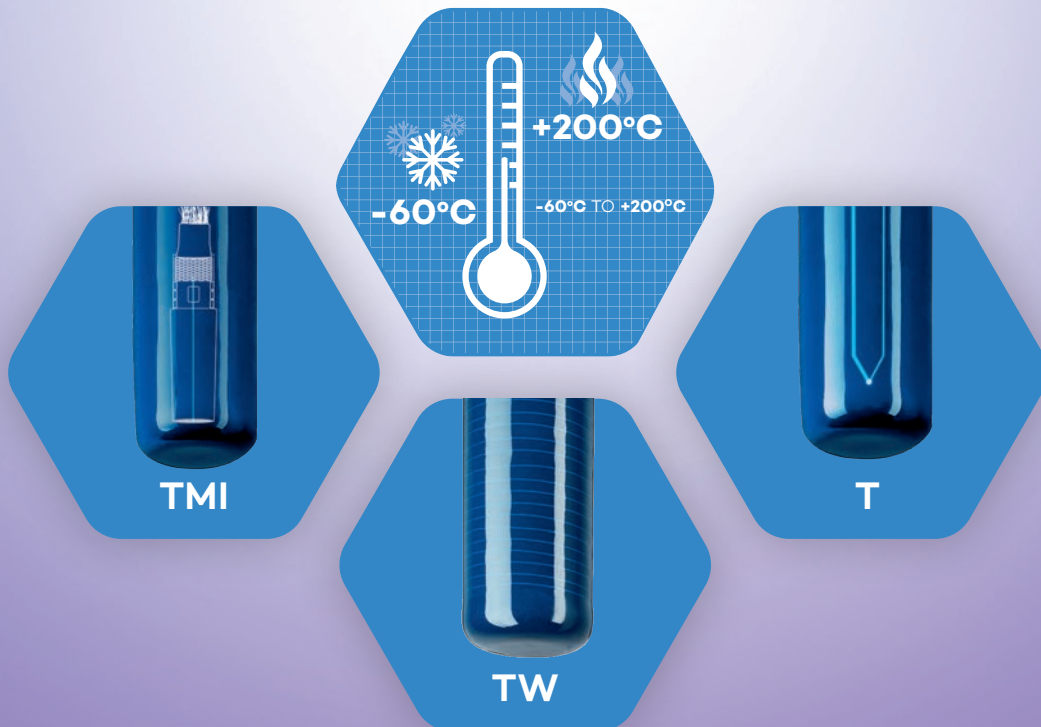
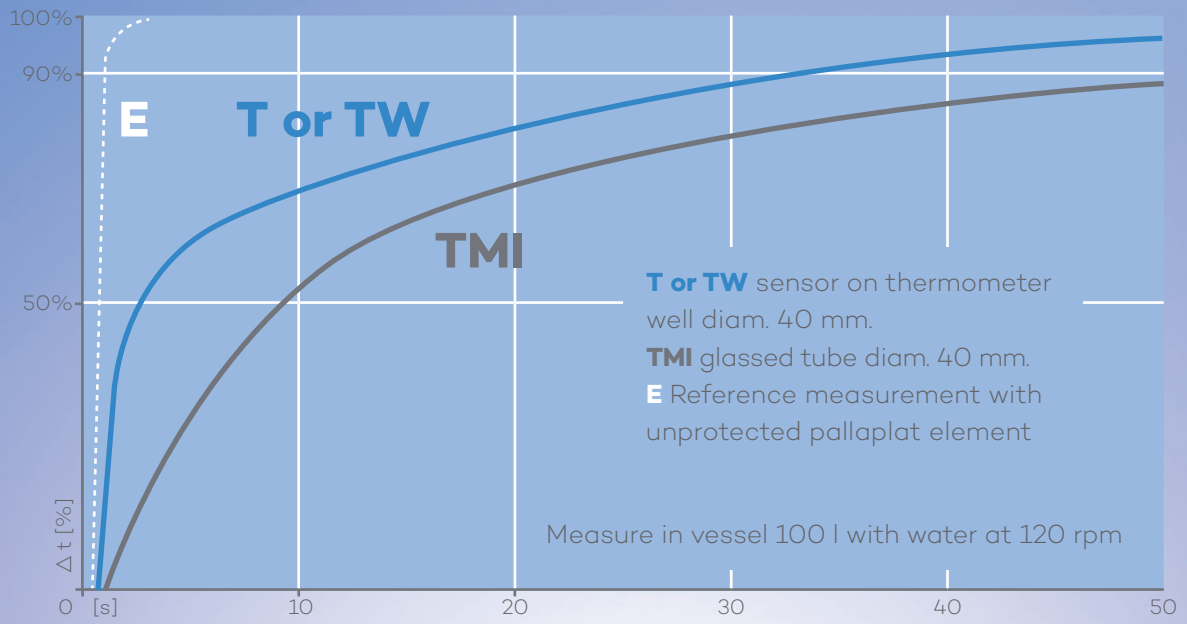

Features and Benefits

Early detection. Precise control

Features	TW	T	TMI
Fastest glass-lined temperature probe	✓		
No sealing elements in the wetted area	✓	✓	✓
Can be fused into the glass lining layer of a baffle, a Quatro-Pipe or a thermometer well	✓	✓	
Up to three measurement points can be arranged on a single probe carrier	✓		
Temperature measurement for complex component designs		✓	
Small measuring element – excellent for installing on small components, e.g. valve cones or spacer rings		✓	
Up to six measurement points can be arranged on a single probe carrier		✓	
Optimised heat transfer realised by a permanent contact pressure, a reduced wall thickness and a gold coated contact point			✓
Can be plugged into a baffle, a thermometer well or a valve stem			✓
Accuracy at 1/3 class B to DIN 43 760 / IEC 751			✓

Benefits	TW	T	TMI
Permits exact reactor temperature regulation	✓	✓	
Optimal operational reliability	✓	✓	✓
Long service life and long-term stability	✓	✓	
Maintenance free	✓	✓	
Measuring insert is easy to replace			✓

Technical Data

Technology	Fused-in Pt 100 thermometer	Fused-in thermocouple	Inserted Pt 100 sensor
Measuring range	-60 to +200 °C	-60 to +200 °C	-25 to +200 °C
Operating temp.	-60 to +200 °C	-60 to +200 °C	-25 to +200 °C
Operating pressure	-1 to +40* bar	-1 to +40* bar	-1 to +40* bar
Ex. protection	II 1/2G Ex ia IIB T6 II 2G Ex ia IIC T6	II 1/2 G Ex ia IIB T6 II 2G Ex ia IIC T6	II 2 G EEx ib IIC T6, T5, T4

* depending on component or nozzle size

TW
FUDED-IN
RESISTANCE
THERMOMETER

TOP LAYER

PT 100
resistance
thermometer

**GROUND
LAYER**

STEEL

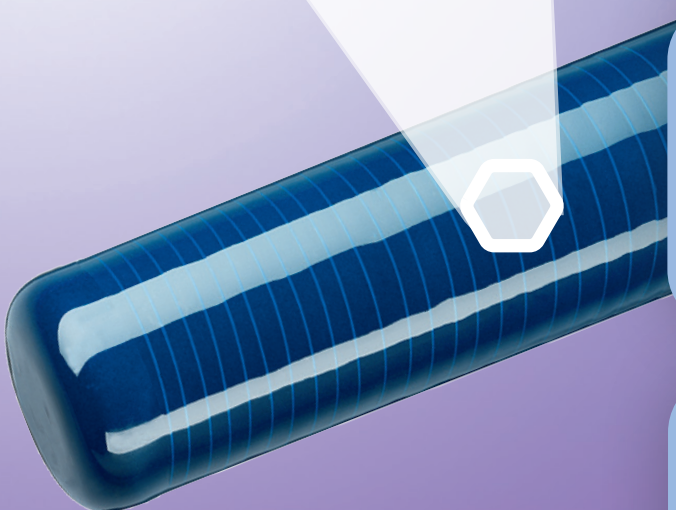
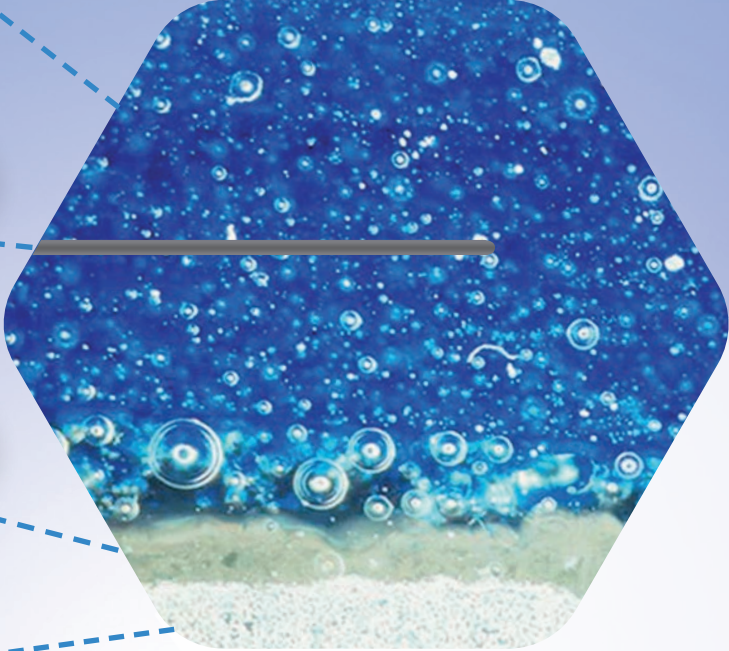

Corrosion monitoring

With analysis of the decomposition voltage always the right decision

The Pfaudler technology not only enables to monitor glass-lined surfaces but also other corrosion-resistant surfaces (e.g. PTFE-coated) of reactors including fittings.

Thanks to the implemented algorithm **false alarms are ruled out**. Reliable information about the condition of the reactor are obtained and the systems connected components. Solutions are available for continuous corrosion monitoring and systems for periodical

mobile corrosion testing. It is thus possible to storage vessels regularly for corrosion damage at low costs and effort.

Corrosion monitoring must be above all **– reliable!**

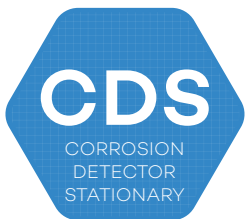

Continuous corrosion monitoring

Continuous corrosion monitoring can be carried out with measuring electrodes fused into the glass lining – the **CDS probe** – in conjunction with the associated electronics – the **Corrosion Detector**. The measuring electronics are connected to the parts being monitored by means of the **point-type electrodes** and the product. These can be embedded in glass-lined baffles, thermo-wells or glass-lined valve stems.

- Principle of **decomposition voltage analysis**
- Measurement **not influenced by electrically conductive fittings**
- Monitors all corrosion-resistant surfaces
- Control measurements **rule out false alarms**
- Displays operating conditions based on defined current thresholds
- Certified for explosion zone 0

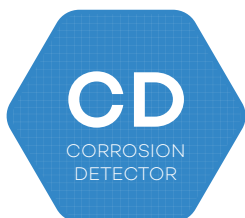

Corrosion Detector (CD)

The Corrosion Detector works on the **principle of the decomposition voltage analysis**. This enables the use of corrosion-resistant conductive fittings without causing a false alarm. The electronics provides four output signals – stand-by, ready, alarm, error.

CDP

CORROSION
DETECTOR
PORTABLE



CDS

CORROSION
DETECTOR
STATIONARY



COP electrodes

Set new standards in terms of reliability and longevity

Bei hochkorrosiven und abrasiven Prozessen in emaillierten Behältern ist eine Korrosionsüberwachung eine unverzichtbare Absicherung zum Schutz der Anlagen und Mitarbeiter.

Mit der Neuentwicklung der gesinter-ten Korrosionsüberwachungselektroden (**COP-Sonde**) verbessert Pfadler sein konkurrenzloses Korrosionsüberwachungssystem weiter und setzt **neue**

Maßstäbe in Sachen Betriebssicherheit und Langlebigkeit – selbst in aggressivsten Prozessen.

Die neue **CryCo-Lock Technologie** ermöglicht zusätzlich auch die Überwachung von aufgeschumpften Turbinen und somit den **perfekten Rundum-Schutz** für Ihren Behälter.



Optimized electrodes - for maximum service life

The technology of corrosion protection monitoring is based on a detailed measuring electrode, the **COP probe**, in conjunction with the associated measuring electronics, the **Corrosion Detector**. The electronics are connected to the parts to be monitored by means of the electrodes via the product.

Due to the significantly increased electrode surface, use with **product conductivities of > 1mS / cm is now also possible**.

In contrast to full metal electrodes, the electrodes embed themselves homogeneously in the glass-lined layer and have **no surface tensions when heated or cooled**. As a result, cracking between the glass-lined layer and the measuring electrodes can not occur and long service lives are possible with built-in components.

In combination with the approval for Ex zone 0, the corrosion monitoring system is suitable for almost all applications.

Benefits

- **Extremely high resistance** to acids and alkalis
- Electrode surface approx. **36x larger**
- Product conductivity **>1mS/cm**
- **No surface tensions** between electrodes and glass-lining
- **Maximum service life** and long-term stability, maintenance-free
- For baffles and quatro-pipes
- ATEX Zone 0

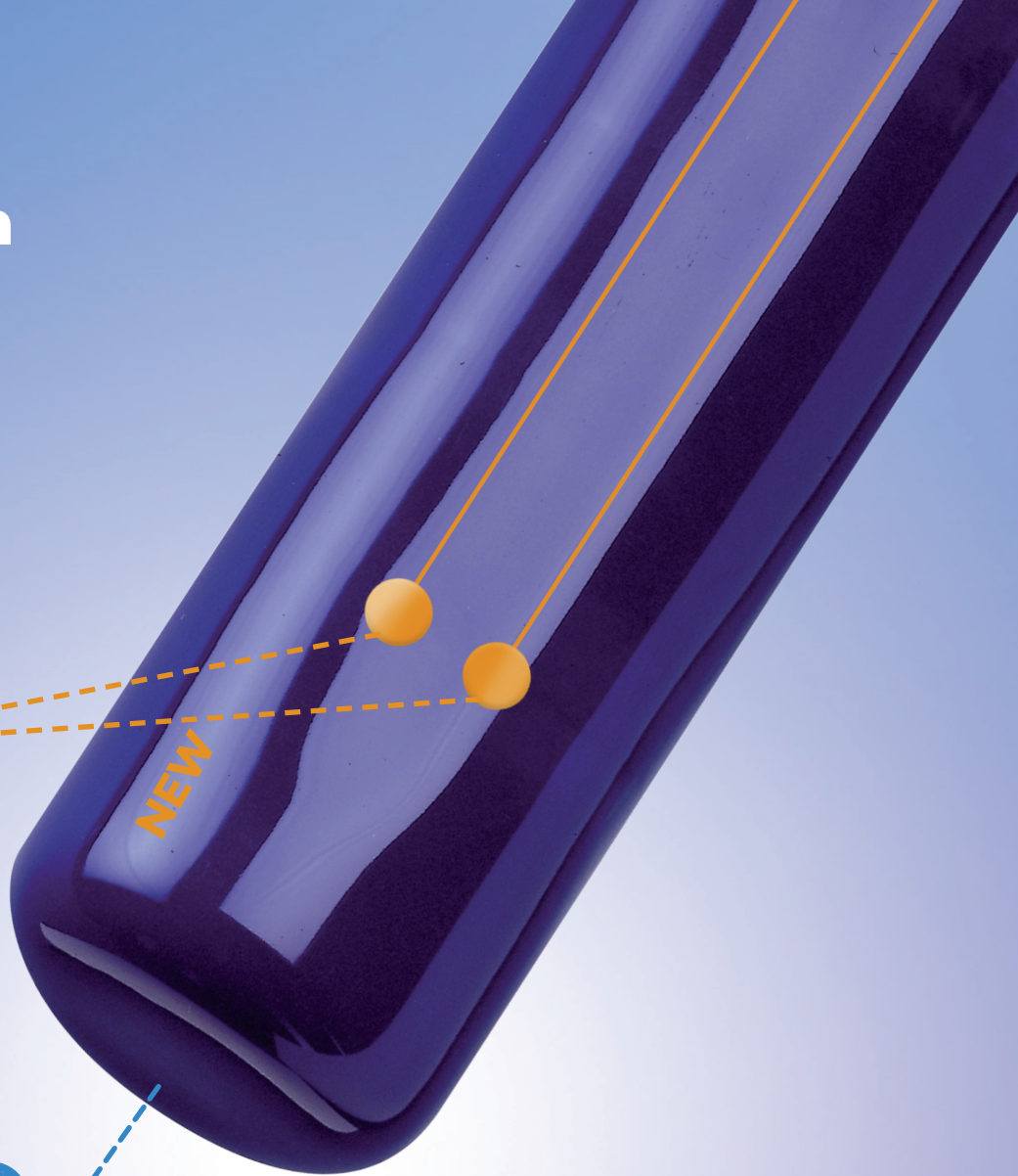

NEW
COP
 CORROSION
 PROOF
 ELECTRODES

**PROBE
 CARRIER**
 BAFFLES /
 QUATRO PIPE®

Laboratory test for the durability of the COP measuring electrodes

Acid / base	Temperature	No measurable corrosion over 3 months
20% hydrochloric acid	110 °C	✓
40% sulfuric acid	120 °C	✓
80% sulfuric acid	120°C	✓
80% phosphoric acid	120°C	✓
30% nitric acid	120°C	✓
aqua regia	120°C	✓
1% caustic soda	80°C	✓

Mobile Corrosion Testing

Corrosion Detector Portable (CDP)

The **Corrosion Detector Portable** offers corrosion testing according to a maintenance plan or when required, and tolerates electrically conductive fittings. The hand-held device is supplied with a PTFE dip probe, a reference electrode and an earthing clamp. Measurements can be transmitted to a PC using the USB adapter cable provided. The associated software is provided on a USB stick.

The **operating principle of the decomposition voltage analysis** is the same as in the stationary measurement system.

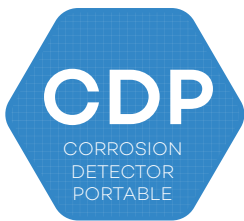

Mobile corrosion testing

The hand-held device is supplied with a PTFE dip probe, a reference electrode and an earthing clamp. Measurements can be transmitted to a PC using the USB adapter cable provided. The associated software helps to administrate the measuring results and to create a test certificate if required.

- Principle of **decomposition voltage analysis**
- Measurement **not influenced by electrically conductive fittings**
- Monitors all corrosion-resistant surfaces
- Control measurements **rule out false alarms**
- Earthing clamp with electronic contact monitoring
- Can store up to 10,000 measurements
- Certified for **explosion zone 1**

Regular and preventive control play a key role in terms of avoiding long downtimes and detect potential damages in an early stage.

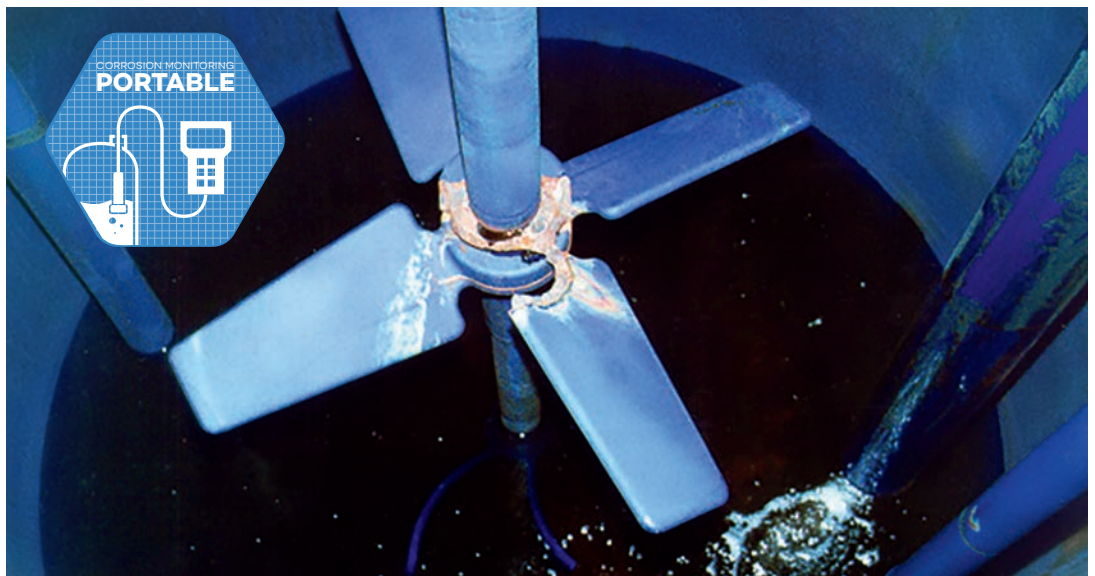



CryCo-Lock

Corrosion monitoring on turbines



Continuous monitoring of the glass lining inside a vessel during operation is indispensable in highly corrosive processes, in order to rule out large and costly tantalum repairs or even rupture of vessels. A corrosion detection system is the solution. Where multi-piece glass-

lined agitators are used, it has never before been possible to monitor the entire agitator assembly.

The use of the Corrosion Detector in conjunction with Pfaudler's new **Conductive Cryo-Lock (CryCo-Lock) technology** has now made this possible.

All-round protection with CryCo-Lock

The moving parts in a reactor are most prone to damage, but can now be monitored for integrity with Pfaudler's new Conductive Cryo-Lock technology. This continuous in-process glass lining monitoring system is **suitable for all Pfaudler Cryo-Lock agitators**.

By means of **two conductive glass spots** shrunk-on turbines are connected to the container mass and thus included in the corrosion monitoring.

This continuous in-process glass lining monitoring system is **suitable for all Pfaudler Cryo-Lock agitators**. This reduces the need to enter the vessel for maintenance purposes to a minimum.

- **Monitoring of all wetted parts** incl. the turbine
- **Homogeneous surface** due to the same thermal expansion coefficients
- **Lower to no need to inspect the vessel for maintenance**

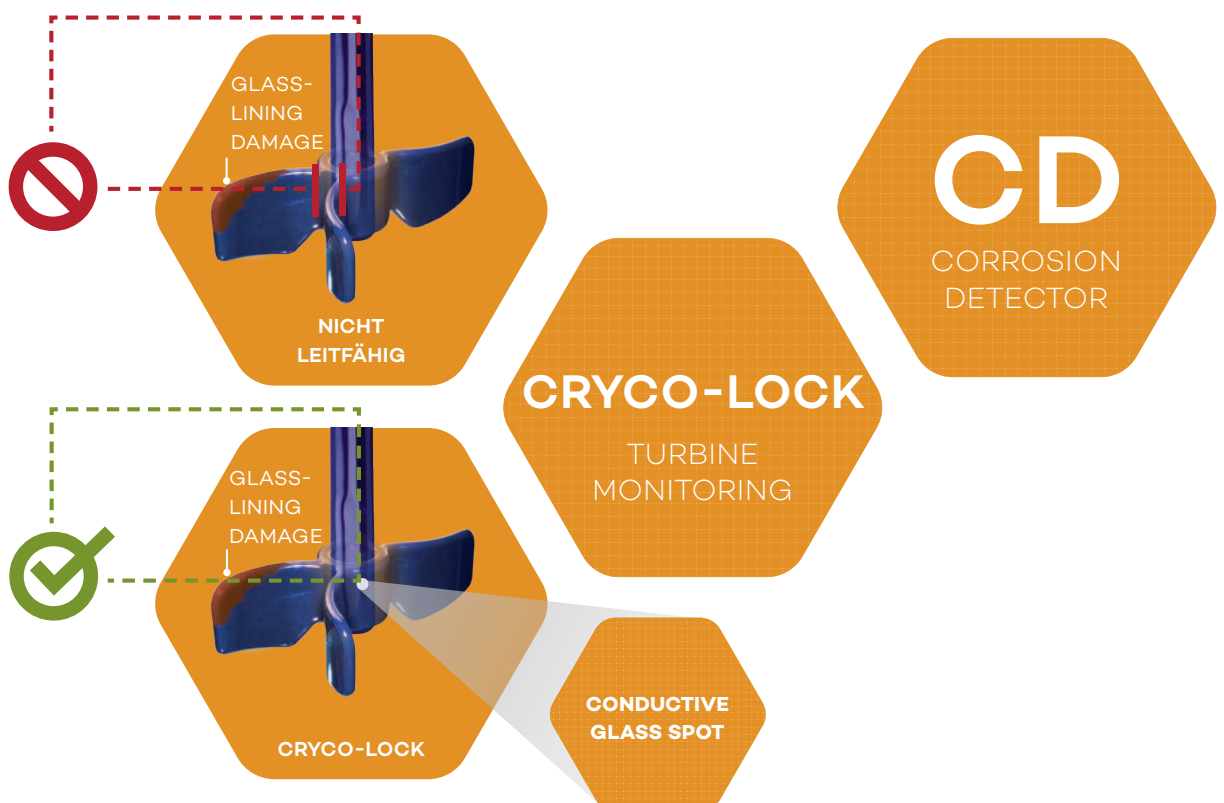

NEW

CRYCO-LOCK

TURBINE
MONITORING

**CRYO-
LOCK
SHAFT**

**CRYO-
LOCK
TURBINE**

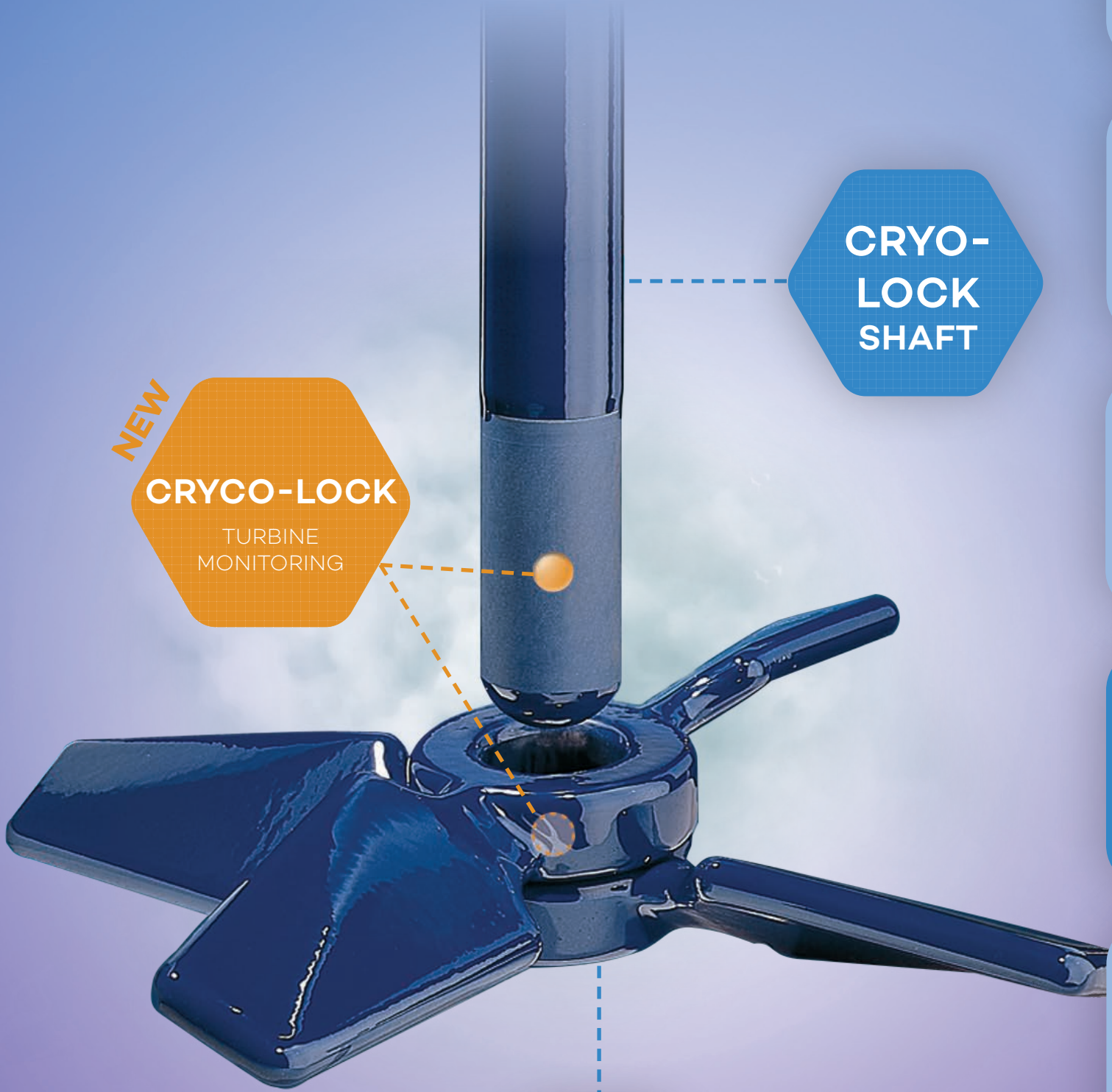

Functional Principle

Features and benefits

The analysis of the decomposition voltage happens in a recurring cycle as changing conditions like the temperature or the pH value have to be considered.

A voltage is applied at regular intervals between the two rhodium electrodes of the P probe, and a base curve is created. Starting from this reference line, the Corrosion Detector calculates a so-called Corrosion Alarm Window. If the current/voltage values are within the Corrosion Alarm Window in two successive control cycles, an alarm message is provided.

Corrosion monitoring must be above all – reliable!

With Pfaudler technology, false alarms are a thing of the past. Whether you monitor your equipment continuously or check it periodically, you can depend on the result every time.

Potentiometric glass-lined monitoring

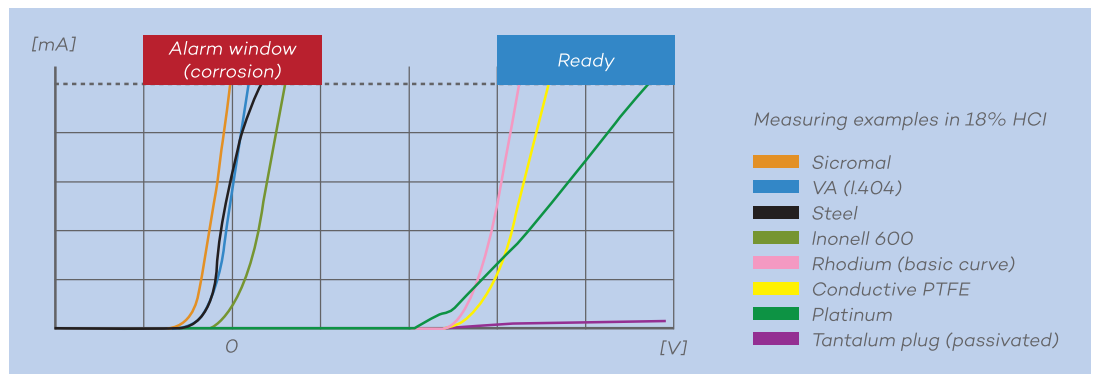

Function in a typical installation situation

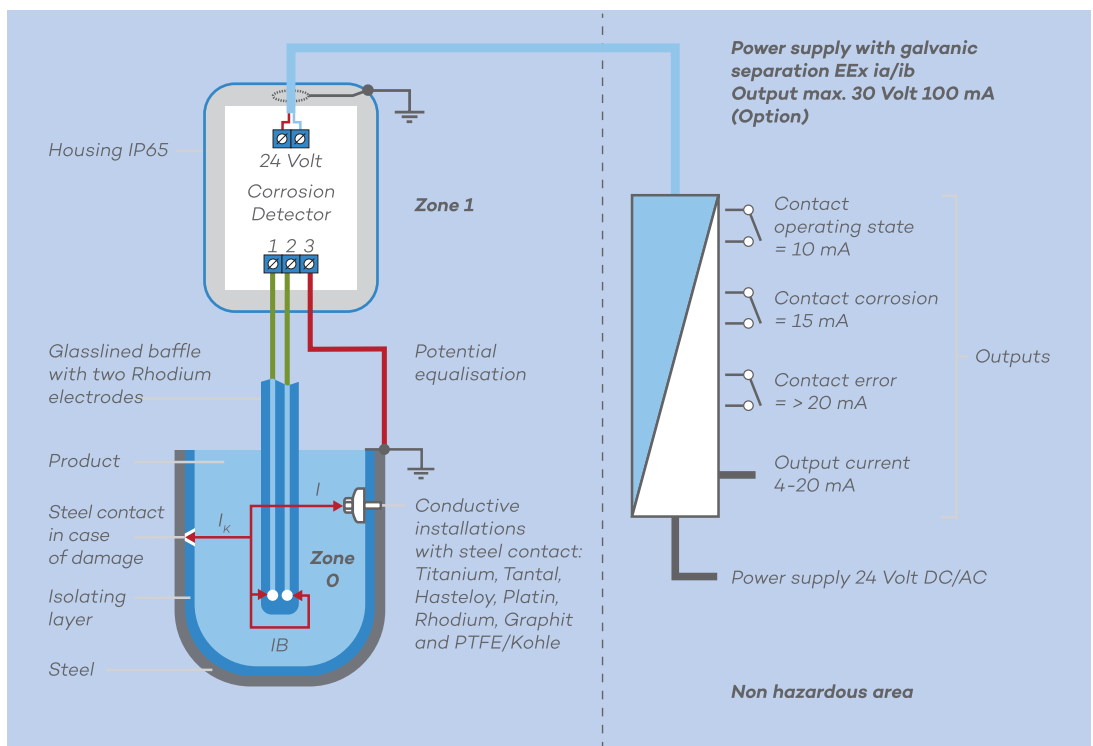

Features and benefits

Features	COP / CD	CDP
Principle of decomposition voltage analysis	√	√
Displays operating conditions based on defined current thresholds	√	
Electronics is integrated into the probe's IP65 terminal box	√	
Earthing clamp with electronic contact monitoring		√
Damage localisation possible to a limited extent	√	√
Integrated conductivity calculator for easier quantitative calculation of conductive additives		√
Can store up to 10,000 measurements		√
Data transmission via a USB interface		√
Visualized directly on handheld display		√

Benefits		
Monitors all corrosion-resistant surfaces	√	√
No false alarms – unambiguous alarm message only if corrosion is detected	√	√
Installation of corrosion-resistant metals is tolerated	√	√

Type	COP probe (P) / Corrosion Detector (CDS)	Corrosion Detector Portable (CDP)
Measuring task	Continuous corrosion monitoring	Mobile corrosion testing
Technology	Decomposition voltage analysis	Decomposition voltage analysis
Measuring range (mS/cm)	>= 1	>= 0.8
Operating temperature (°C)	-60 to +200	0 to +50
Operating pressure (bar)	-1 to +40*	-
Explosion protection	COP: II 1/2 G Ex ia IIB T6 Ga/Gb or II 2 G Ex ia IIC T6 Gb CDS: II 2(1) G or II 2G Ex ia IIC T6 Gb or Ex ib IIC T6 Gb	II 2G Ex ib 11B T3 Gb -10°C ≤ Ta ≤ +50°C

* depending on component or nozzle size

Level Measurement

Fast, precise, durable



Continuous level measurement

Capacitive

Our FS probe type uses the capacitive method. A fused-in electrode strip forms a capacitor with the steel tube. If the probe comes into contact with product instead of air in the vicinity of the electrode, the capacitance changes.

- High mechanical strength and chemical resistance through the use of glassed steel
- No sealing elements



Radar

Levelpulse radar sensors emit microwave signals, and are used for continuous level monitoring of corrosive fluids in reactors.

- Low transmission frequency – insensitive to product deposits
- Accurate measurement even in the presence of temperature fluctuations
- Adjustment without filling or emptying the reactor



Limit level measurement

Capacitive

The FT measuring probes follow the capacitive principle. The electrode used for this purpose is annular. Applications range from full and empty alerts for vessels and detection of interlayers to protecting pumps from running dry.

- High mechanical strength and chemical resistance through the use of glassed steel
- No sealing elements



Vibration

Safety Swings rely on the tuning fork principle to achieve a limit level measurement that is accurate to the millimetre – regardless of the medium's density and viscosity. The probe can be used as a maximum limit switch, as an additional overflow safety device, as a minimum limit switch or as protection against running dry.

- High mechanical strength and chemical resistance through the use of glassed steel
- Works perfectly even in foam, bubbles and suspended particles
- Certified as an overflow safety device under WH (German Water Management Act)

LEVEL MEASUREMENT



Sampling Systems

Reliable, maintenance free, variable

Generally, sampling systems are used as an alternative for the online liquid analysis. It is crucial here that the production process is not interrupted, that no contamination occurs and that surfaces which come into contact with the product are protected against aggressive media. Yet another area in which the glass lining from Pfaudler comes into its own.

The fleXampler loop used in combination with the Pfaudler Quatro-Pipe, for example, provides a complete measuring system with which samples are taken and temperature, pH value and corrosion monitoring are measured or monitored at the same time. And all of this with just one vessel nozzle.



fleXampler

The fleXampler standard sampling system is the ideal solution for the reliable and closed sampling of fluid media from reactors and vessels. A Dip-Pipe or a Quatro-Pipe baffle is mounted on an available vessel nozzle. The sample can be taken by inserting the PTFE suction hose into the Quatro-Pipe or Dip-Pipe. The connection on the lower flange of the fleXampler sampling system enables the use of the Dip-Pipe or Quatro-Pipe to inject fluid media.

- Modular design
- Large outlet for sampling
- Parts with PFA internal coating (FDA-certified)
- TA Luft (Clean Air Act) compliant
- Options
 - Design with recirculating pump
 - Automatic control with motorised valves
 - Sampling flask cage



fleXampler loop

The fleXampler loop continuous sampling system really comes into its own when used with a Quatro-Pipe baffle, as this configuration only requires one vessel nozzle for two or more functionalities. The sample is taken near the agitator by means of an internal PTFE tube. All parts that come into contact with the product are metal-free. Thanks to the constant circulation (loop), there is no need to clean the sampling device. The loop circulation system also offers the option of integrating a pH-ring probe without any effort or expense.

- Maintenance-free and self-cleaning for representative results
- Suitable for viscous substances
- Piston syringe with glass cylinder for quick visual inspection
- No escape of gas or product
- Compressed air diaphragm pump with diaphragm monitoring designed for zone 0
- Surfaces in contact with product have highly corrosion-resistant coating (glass lining, PFA, PTFE)

SAMPLING SYSTEMS

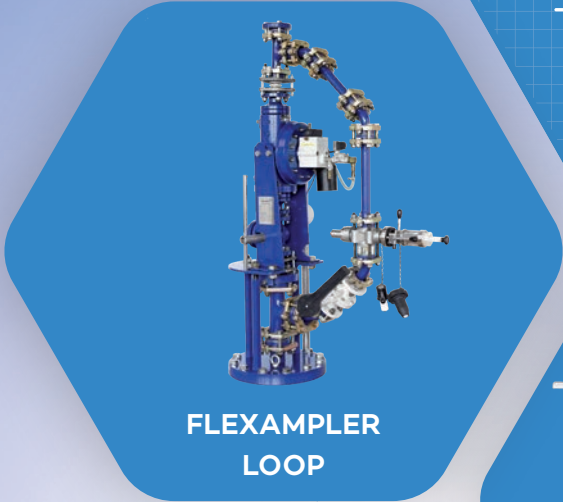
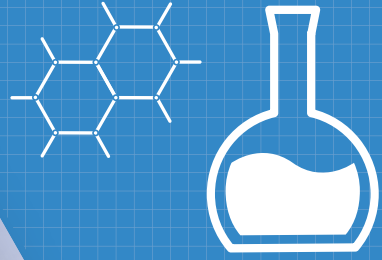

FLEXAMPLER LOOP



FLEXAMPLER STANDARD

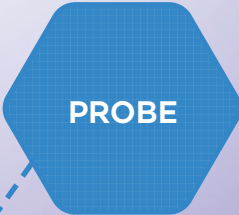
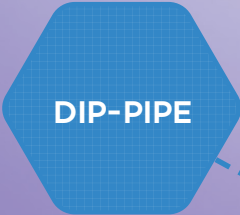
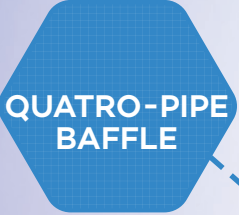

Global Services Capability



Pfaunder guarantees a global service during the whole process, pre and post sales, with the largest service organization in different sectors.

Our Service Centers are close to your site to guarantee fast and flexible services. More than 150 people are at your service. We are present in several countries with field engineers who can provide you with comprehensive support for installation, commissioning and maintenance of your facilities and plants.

Our Services

From comprehensive engineering and technical services to our rapid, reliable field services and aftermarket parts supply, you can count on us to keep your process system operating properly:

Engineering

- Consultancy Services
- Pilot testing / toll operation
- Process engineering

Installation, Commissioning, Start up

- Planning
- Project management
- Installations
- Lining measurement technologies

Maintenance and aftersales

- Maintenance & repair
- Troubleshooting
- Glass inspection, reglazing and repair
- Shutdown services
- Spare / Replacement parts
- Mechanical seal exchange



Pfautler Safety First

Delivering excellent safety performance is necessary for any company operating in the process industries. Over the years, and all over the world, Pfautler has provided security in its products and highly-qualified service teams.

We are committed to safety and our field service organization that provides installation and maintenance for your facility, has developed strict safety policies to ensure a safe working environment.

Pfautler guarantees:

- skilled professionals properly prepared and qualified on security and risk management
- observance of international standards
- use of professional personal protective equipment
- reduced operating risks

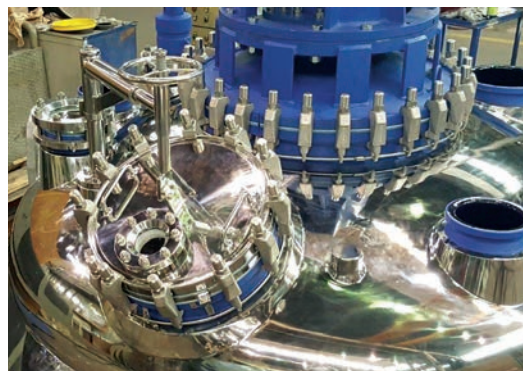

Refurbishing, reglazing and inspection

In addition to its expertise in manufacturing and market products and engineered solutions, Pfautler has core expertise in the service area of full equipment refurbishing. The reactors are completely reglazed, refurbished combined with a suitable retrofitting of all devices or accessories, producing an appropriate program to meet specific customer needs and timeframes. All this is in compliance with international and European standards. Our technicians provide a complete glass lining inspection program to ensure that your reactor is in proper condition for safe and efficient operation.

Our commitment to quality components means that our technologies are often in service for many years. However, our pioneering approach means that during this time we have developed new solutions. Whether your process is changing or you are looking to further optimise performance levels, an upgrade to our new technologies can improve the capabilities of your reactor.

Notes

